

SK50BGLL07F3TUFBPp

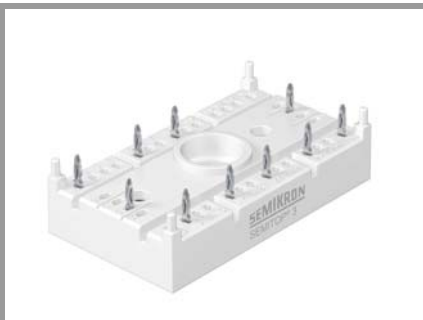

SEMITOP® 3 Press-Fit

IGBT module

SK50BGLL07F3TUFBPp

Features

- Compact design
- One screw mounting module
- Solder free mounting with Press-Fit terminals
- Fully compatible with other SEMITOP® Press-Fit types
- Improved thermal performances by aluminium oxide substrate
- 650V Fast Trench IGBT technology
- Ultrafast technology FWD
- Integrated NTC temperature sensor
- UL recognized, file no. E 63 532

Typical Applications*

- Switching (not for linear use)
- Inverter
- Switched mode power supplier
- UPS

Absolute Maximum Ratings				
Symbol	Conditions	Values	Unit	
IGBT 2				
V_{CES}	$T_j = 25\text{ °C}$	650	V	
I_C	$T_j = 150\text{ °C}$	$T_s = 25\text{ °C}$	46	A
		$T_s = 70\text{ °C}$	34	A
I_C	$T_j = 175\text{ °C}$	$T_s = 25\text{ °C}$	51	A
		$T_s = 70\text{ °C}$	41	A
I_{Cnom}		50	A	
I_{CRM}	$I_{CRM} = 3 \times I_{Cnom}$	150	A	
V_{GES}		-20 ... 20	V	
t_{psc}	$V_{CC} = 400\text{ V}$ $V_{GE} \leq 15\text{ V}$ $V_{CES} \leq 650\text{ V}$	$T_j = 150\text{ °C}$	5	μs
T_j		-40 ... 175	$^{\circ}\text{C}$	

Absolute Maximum Ratings				
Symbol	Conditions	Values	Unit	
Diode 1				
V_{RRM}	$T_j = 25\text{ °C}$	1600	V	
I_F	$T_j = 125\text{ °C}$	$T_s = 25\text{ °C}$	30	A
		$T_s = 70\text{ °C}$	20	A
I_F	$T_j = 150\text{ °C}$	$T_s = 25\text{ °C}$	35	A
		$T_s = 70\text{ °C}$	26	A
I_{Fnom}		25	A	
I_{FSM}	10 ms sin 180°	$T_j = 25\text{ °C}$	220	A
		$T_j = 150\text{ °C}$	200	A
i^2t	10 ms, sin 180°, $T_j = 150\text{ °C}$	200	A^2s	
T_j		-40 ... 150	$^{\circ}\text{C}$	

Absolute Maximum Ratings				
Symbol	Conditions	Values	Unit	
Diode 2				
V_{RRM}	$T_j = 25\text{ °C}$	600	V	
I_F	$T_j = 150\text{ °C}$	$T_s = 25\text{ °C}$	60	A
		$T_s = 70\text{ °C}$	42	A
I_F	$T_j = 175\text{ °C}$	$T_s = 25\text{ °C}$	69	A
		$T_s = 70\text{ °C}$	52	A
I_{Fnom}		30	A	
I_{FRM}	$I_{FRM} = 2 \times I_{Fnom}$	60	A	
I_{FSM}	10 ms sin 180°	$T_j = 25\text{ °C}$	300	A
		$T_j = 175\text{ °C}$	300	A
T_j		-40 ... 175	$^{\circ}\text{C}$	

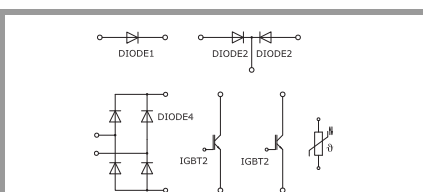

BGLL_TBP

SK50BGLL07F3TUFBPp

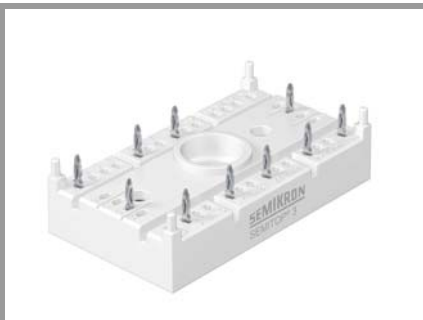

SEMITOP® 3 Press-Fit

IGBT module

SK50BGLL07F3TUFBPp

Features

- Compact design
- One screw mounting module
- Solder free mounting with Press-Fit terminals
- Fully compatible with other SEMITOP® Press-Fit types
- Improved thermal performances by aluminium oxide substrate
- 650V Fast Trench IGBT technology
- Ultrafast technology FWD
- Integrated NTC temperature sensor
- UL recognized, file no. E 63 532

Typical Applications*

- Switching (not for linear use)
- Inverter
- Switched mode power supplier
- UPS

Absolute Maximum Ratings				
Symbol	Conditions		Values	Unit
Diode 4				
V_{RRM}			1600	V
I_F	$T_j = 125\text{ °C}$	$T_s = 25\text{ °C}$	44	A
		$T_s = 70\text{ °C}$	29	A
I_F	$T_j = 150\text{ °C}$	$T_s = 25\text{ °C}$	51	A
		$T_s = 70\text{ °C}$	38	A
I_{Fnom}			35	A
I_{FSM}	10 ms sin 180°	$T_j = 25\text{ °C}$	370	A
		$T_j = 150\text{ °C}$	270	A
I^2t	10 ms, sin 180°, $T_j = 150\text{ °C}$		365	A ² s
T_j			-40 ... 150	°C

Absolute Maximum Ratings				
Symbol	Conditions		Values	Unit
Module				
$I_{t(RMS)}$	$T_{terminal} = 100\text{ °C}$, $T_s = 60\text{ °C}$, per pin		40	A
T_{stg}			-40 ... 125	°C
V_{isol}	AC, sinusoidal, t = 1 min		2500	V

Characteristics						
Symbol	Conditions		min.	typ.	max.	Unit
IGBT 2						
$V_{CE(sat)}$	$I_C = 50\text{ A}$ $V_{GE} = 15\text{ V}$ chipelevel	$T_j = 25\text{ °C}$	1.85	2.22		V
		$T_j = 150\text{ °C}$	2.18	2.55		V
V_{CE0}	chipelevel	$T_j = 25\text{ °C}$	1.10	1.20		V
		$T_j = 150\text{ °C}$	1.00	1.10		V
r_{CE}	$V_{GE} = 15\text{ V}$ chipelevel	$T_j = 25\text{ °C}$	15	20		mΩ
		$T_j = 150\text{ °C}$	24	29		mΩ
$V_{GE(th)}$	$V_{GE} = V_{CE}\text{ V}$, $I_C = 0.8\text{ mA}$		4.2	5.1	5.6	V
I_{CES}	$V_{GE} = 0\text{ V}$ $V_{CE} = 650\text{ V}$	$T_j = 25\text{ °C}$			0.005	mA
		$T_j = 150\text{ °C}$			-	mA
C_{ies}	$V_{CE} = 25\text{ V}$ $V_{GE} = 0\text{ V}$	$f = 1\text{ MHz}$		3.1		nF
C_{oes}		$f = 1\text{ MHz}$		0.116		nF
C_{res}		$f = 1\text{ MHz}$		0.09		nF
Q_G	$V_{GE} = -8\text{ V...} + 15\text{ V}$			185		nC
R_{Gint}	$T_j = 25\text{ °C}$			0		Ω
$t_{d(on)}$	$V_{CC} = 300\text{ V}$	$T_j = 150\text{ °C}$		169		ns
t_r	$I_C = 50\text{ A}$ $R_{Gon} = 16\text{ Ω}$ $R_{Goff} = 16\text{ Ω}$	$T_j = 150\text{ °C}$		81		ns
		$T_j = 150\text{ °C}$		2.79		mJ
E_{on}				2.79		mJ
$t_{d(off)}$	$di/dt_{on} = 3077\text{ A/μs}$	$T_j = 150\text{ °C}$		431		ns
t_f	$di/dt_{off} = 3636\text{ A/μs}$	$T_j = 150\text{ °C}$		28		ns
E_{off}	$V_{GE\ neg} = -15\text{ V}$ $V_{GE\ pos} = 15\text{ V}$	$T_j = 150\text{ °C}$		1.03		mJ
$R_{th(j-s)}$	per IGBT			1.1		K/W

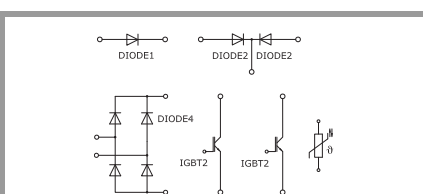

BGLL_TBP

SK50BGLL07F3TUFBPp

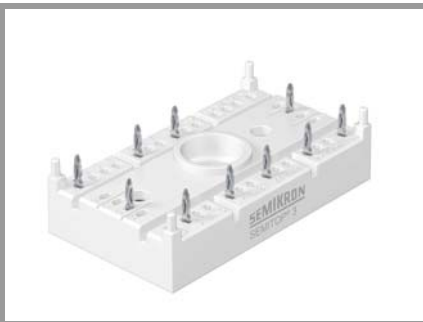

SEMITOP® 3 Press-Fit

IGBT module

SK50BGLL07F3TUFBPp

Features

- Compact design
- One screw mounting module
- Solder free mounting with Press-Fit terminals
- Fully compatible with other SEMITOP® Press-Fit types
- Improved thermal performances by aluminium oxide substrate
- 650V Fast Trench IGBT technology
- Ultrafast technology FWD
- Integrated NTC temperature sensor
- UL recognized, file no. E 63 532

Typical Applications*

- Switching (not for linear use)
- Inverter
- Switched mode power supplier
- UPS

Characteristics						
Symbol	Conditions		min.	typ.	max.	Unit
Diode 1						
V_F	$I_F = 25\text{ A}$	$T_j = 25\text{ °C}$		1.26	1.70	V
	chipelevel	$T_j = 125\text{ °C}$		1.26	1.67	V
V_{F0}	chipelevel	$T_j = 25\text{ °C}$		0.88	0.98	V
		$T_j = 125\text{ °C}$		0.73	0.83	V
r_F	chip	$T_j = 25\text{ °C}$		15	29	mΩ
		$T_j = 125\text{ °C}$		21	34	mΩ
I_{RRM}	$I_F = 25\text{ A}$			-		A
Q_{rr}				-		μC
E_{rr}				-		mJ
$R_{th(j-s)}$				1.8		K/W

Characteristics						
Symbol	Conditions		min.	typ.	max.	Unit
Diode 2						
V_F	$I_F = 30\text{ A}$	$T_j = 25\text{ °C}$		1.85	2.35	V
	chipelevel	$T_j = 150\text{ °C}$		1.10	1.40	V
V_{F0}		$T_j = 25\text{ °C}$		1.55	2.05	V
		$T_j = 150\text{ °C}$		0.90	1.20	V
r_F	chipelevel	$T_j = 25\text{ °C}$		10	10	mΩ
		$T_j = 150\text{ °C}$		6.7	6.7	mΩ
I_{RRM}	$I_F = 50\text{ A}$	$T_j = 150\text{ °C}$		58		A
Q_{rr}	$di/dt_{off} = 3077\text{ A/μs}$	$T_j = 150\text{ °C}$		1.8		μC
E_{rr}	$V_{GE} = -15\text{ V}$ $V_{CC} = 300\text{ V}$	$T_j = 150\text{ °C}$		0.46		mJ
$R_{th(j-s)}$	per Diode			1.5		K/W

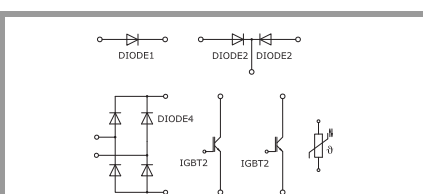

BGLL_TBP

SK50BGLL07F3TUFBPp

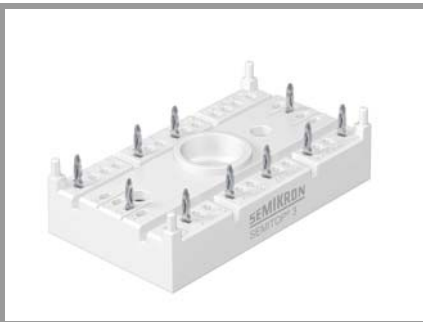

SEMITOP® 3 Press-Fit

IGBT module

SK50BGLL07F3TUFBPp

Features

- Compact design
- One screw mounting module
- Solder free mounting with Press-Fit terminals
- Fully compatible with other SEMITOP® Press-Fit types
- Improved thermal performances by aluminium oxide substrate
- 650V Fast Trench IGBT technology
- Ultrafast technology FWD
- Integrated NTC temperature sensor
- UL recognized, file no. E 63 532

Typical Applications*

- Switching (not for linear use)
- Inverter
- Switched mode power supplier
- UPS

Characteristics						
Symbol	Conditions		min.	typ.	max.	Unit
Diode 4						
V_F	$I_F = 35\text{ A}$	$T_j = 25\text{ °C}$		1.20	1.60	V
		chipelevel	$T_j = 125\text{ °C}$	1.19	1.56	V
V_{F0}	chip	$T_j = 25\text{ °C}$		0.88	0.98	V
		$T_j = 125\text{ °C}$		0.73	0.83	V
r_F	chipelevel	$T_j = 25\text{ °C}$		13	18	mΩ
		$T_j = 125\text{ °C}$		13	21	mΩ
I_{RRM}				-		A
Q_{rr}				-		μC
E_{rr}				-		mJ
$R_{th(j-s)}$	per Diode			1.3		K/W

Characteristics						
Symbol	Conditions		min.	typ.	max.	Unit
Module						
M_s	to heatsink		2.25		2.5	Nm
w	weight			30		g

Characteristics						
Symbol	Conditions		min.	typ.	max.	Unit
Temperature Sensor						
R_{100}	$T_r = 100\text{ °C}$			$493 \pm 5\%$		Ω
$B_{100/125}$	$R_{(T)} = R_{100} \exp[B_{100/125}(1/T - 1/T_{100})]$; T[K];			$3550 \pm 2\%$		K

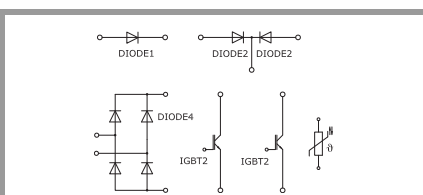

BGLL_TBP

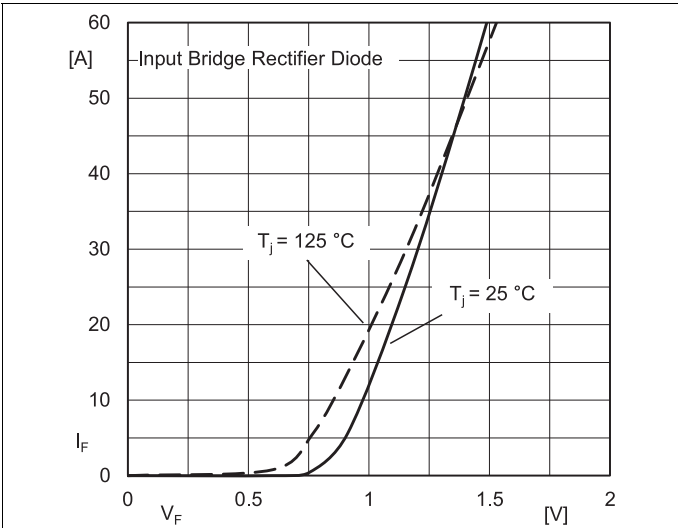

Fig. 1: Typ. Diode4 forward characteristic, incl. R_{CC+EE}

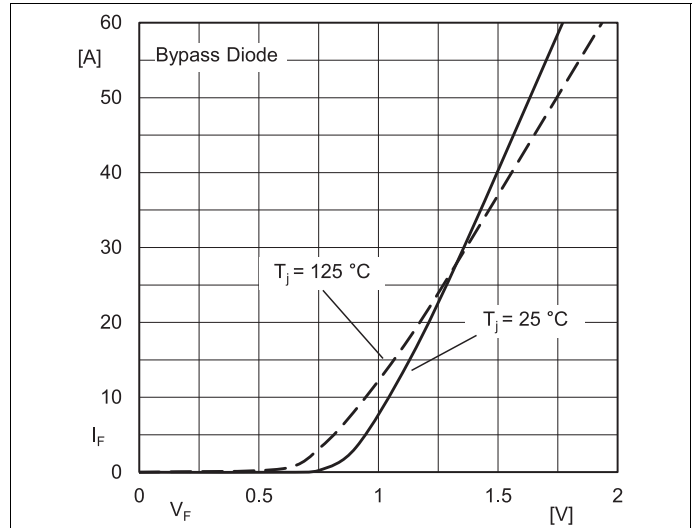

Fig. 2: Typ. Diode1 forward characteristic, incl. R_{CC+EE}

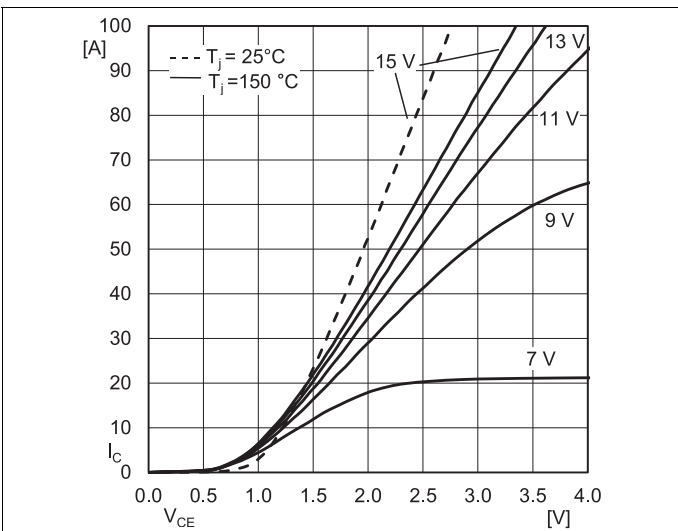

Fig. 3: Typ. IGBT output characteristic, inclusive R_{CC+EE}

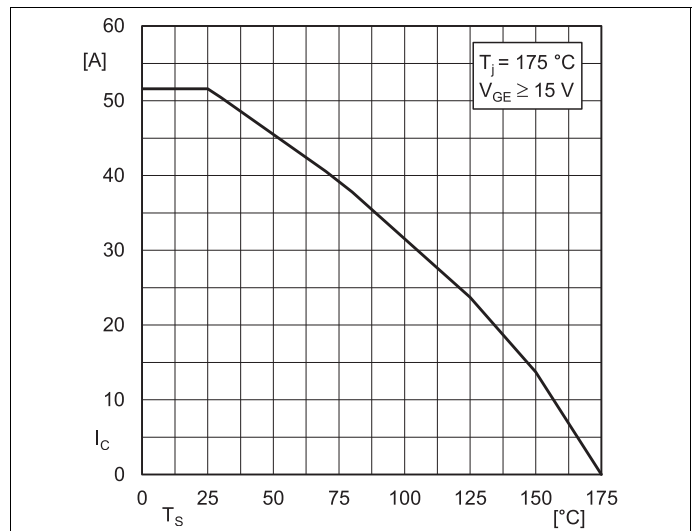

Fig. 4: Rated IGBT current vs. temperature $I_C = f(T_s)$

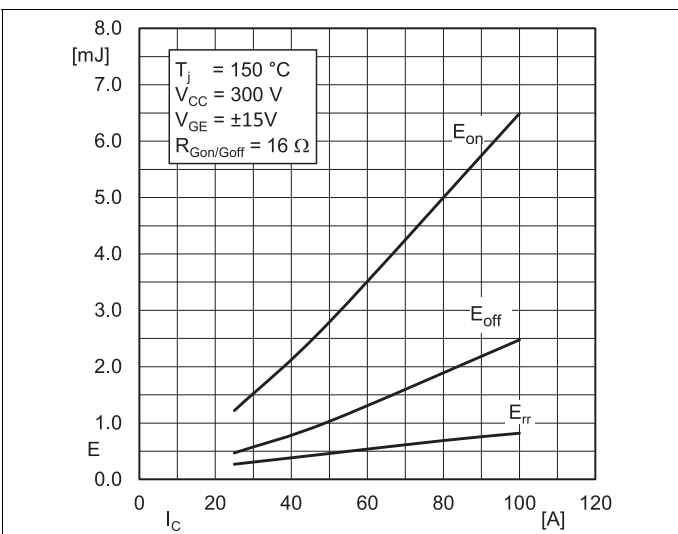

Fig. 5: Typ. turn-on /-off energy = $f(I_C)$

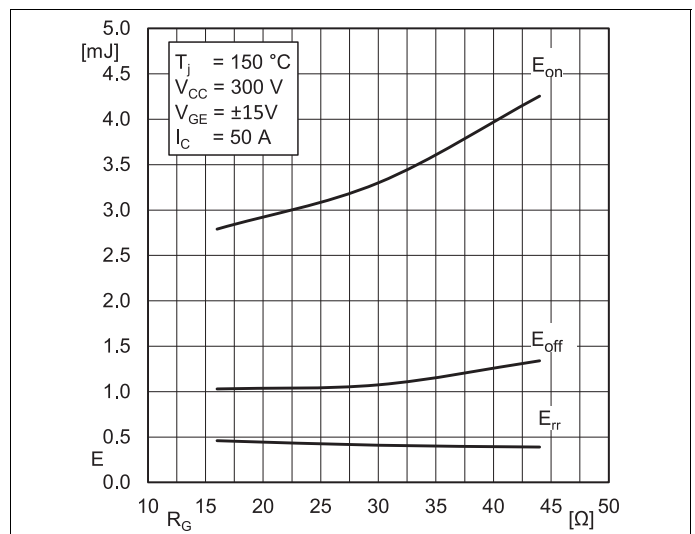

Fig. 6: Typ. turn-on /-off energy = $f(R_G)$

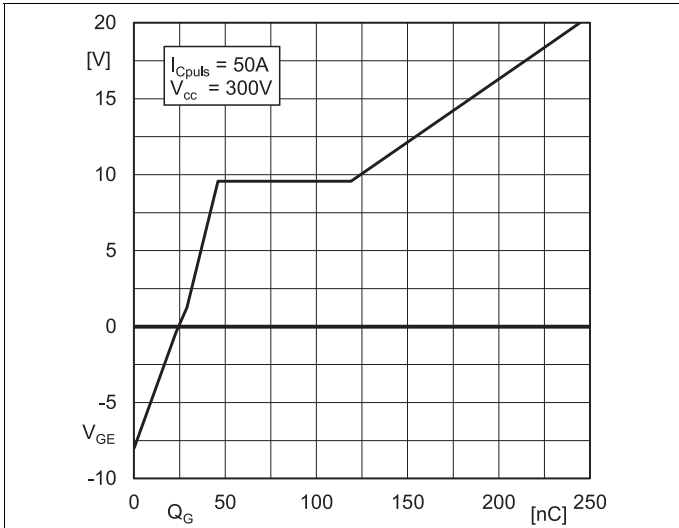

Fig. 7: Typ. gate charge characteristic

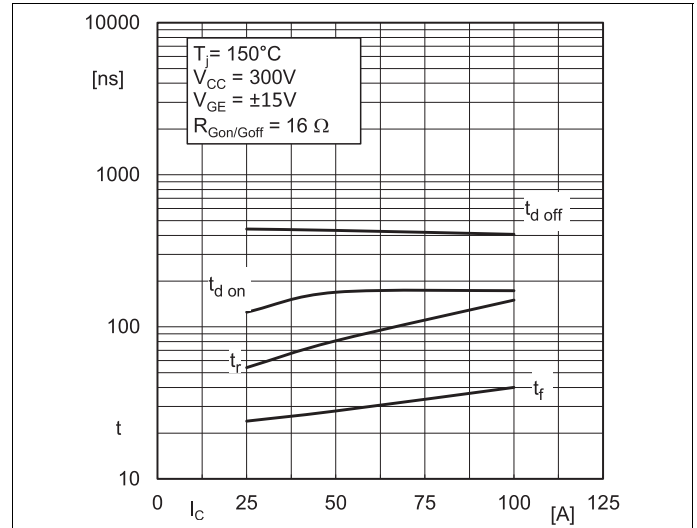

Fig. 8: Typ. switching times vs. I_C

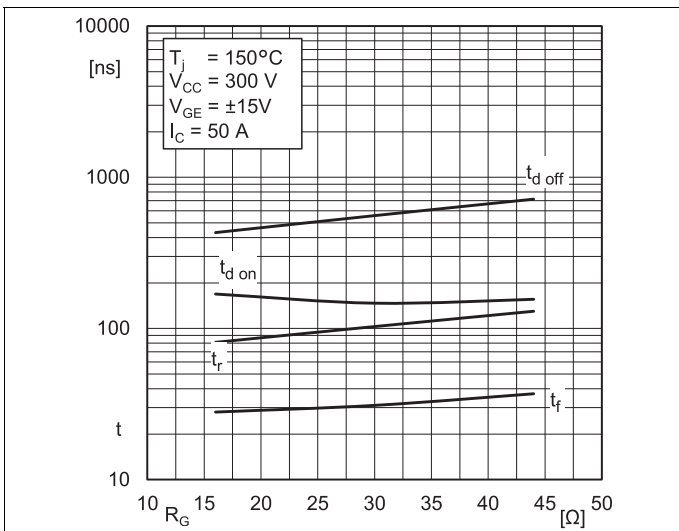

Fig. 9: Typ. switching times vs. gate resistor R_G

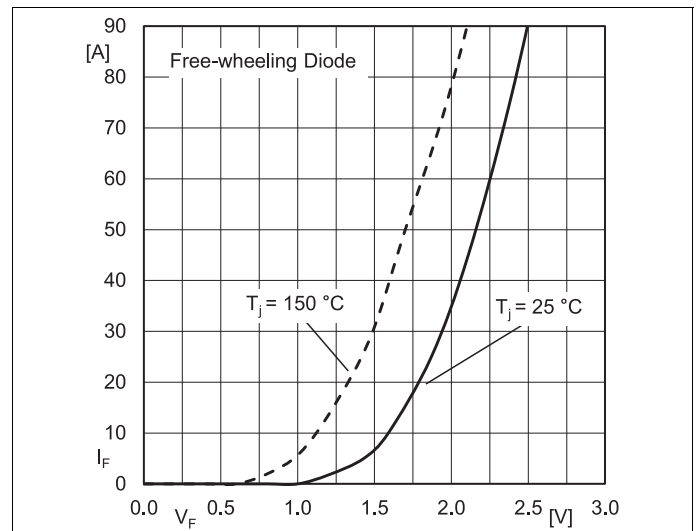
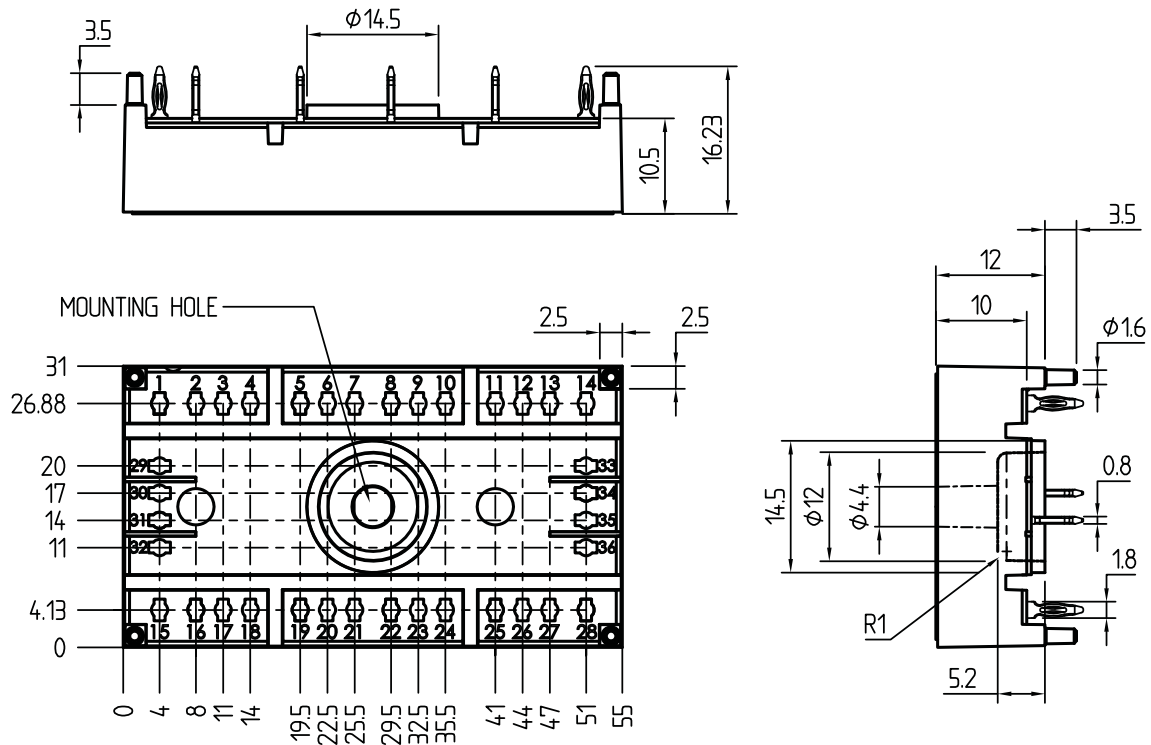

Fig. 10: Typ. Diode2 forward characteristic, incl. $R_{CC+EE'}$

SK50BGLL07F3TUFBPp

dimensions in mm
tolerance system: ISO 2768-m



Suggested drilled hole diameter for terminal pins in the circuit board:

- minimum: 1.575mm
- typical: 1.6mm
- maximum: 1.625mm

Suggested hole diameter for the mounting pins in the circuit board: 2mm

These documents are SEMIKRON properties. SEMIKRON reserves all copyrights.
All copying and transmitting of this information requires written permission.
For the case of industrial property rights, SEMIKRON reserves all rights.

SEMITOP 3 Press-Fit

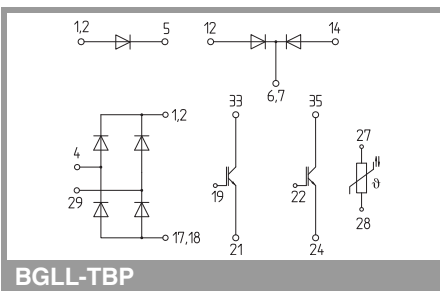

BGLL-TBP

This is an electrostatic discharge sensitive device (ESDS), international standard IEC 60747-1, chapter IX.

***IMPORTANT INFORMATION AND WARNINGS**

The specifications of SEMIKRON products may not be considered as guarantee or assurance of product characteristics ("Beschaffenheitsgarantie"). The specifications of SEMIKRON products describe only the usual characteristics of products to be expected in typical applications, which may still vary depending on the specific application. Therefore, products must be tested for the respective application in advance. Application adjustments may be necessary. The user of SEMIKRON products is responsible for the safety of their applications embedding SEMIKRON products and must take adequate safety measures to prevent the applications from causing a physical injury, fire or other problem if any of SEMIKRON products become faulty. The user is responsible to make sure that the application design is compliant with all applicable laws, regulations, norms and standards. Except as otherwise explicitly approved by SEMIKRON in a written document signed by authorized representatives of SEMIKRON, SEMIKRON products may not be used in any applications where a failure of the product or any consequences of the use thereof can reasonably be expected to result in personal injury. No representation or warranty is given and no liability is assumed with respect to the accuracy, completeness and/or use of any information herein, including without limitation, warranties of non-infringement of intellectual property rights of any third party. SEMIKRON does not assume any liability arising out of the applications or use of any product; neither does it convey any license under its patent rights, copyrights, trade secrets or other intellectual property rights, nor the rights of others. SEMIKRON makes no representation or warranty of non-infringement or alleged non-infringement of intellectual property rights of any third party which may arise from applications. Due to technical requirements our products may contain dangerous substances. For information on the types in question please contact the nearest SEMIKRON sales office. This document supersedes and replaces all information previously supplied and may be superseded by updates. SEMIKRON reserves the right to make changes.