

# SKiiP 24GB07E3V1

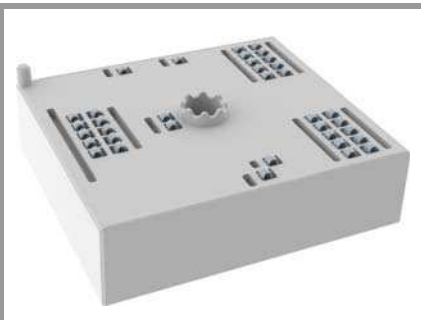

MiniSKiiP® 2 Dual

## SKiiP 24GB07E3V1

### Features

- 650V Trench IGBTs
- Robust and soft diodes in CAL technology
- Highly reliable spring contacts for electrical connections
- UL recognised: File no. E63532
- NTC T-Sensor

### Remarks

- Max. case temperature limited to  $T_C = 125^\circ\text{C}$
- Product reliability results valid for  $T_j \leq 150^\circ\text{C}$  (recommended  $T_{j,op} = -40 \dots +150^\circ\text{C}$ )

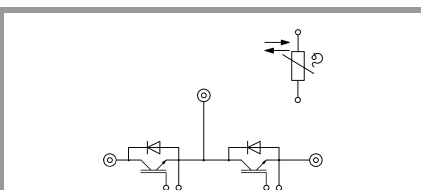

GB

### Absolute Maximum Ratings

Symbol	Conditions	Values	Unit	
<b>Inverter - IGBT</b>				
$V_{CES}$	$T_j = 25^\circ\text{C}$	650	V	
$I_C$	$T_j = 175^\circ\text{C}$	$T_s = 25^\circ\text{C}$	185	A
		$T_s = 70^\circ\text{C}$	148	A
$I_{Cnom}$		150	A	
$I_{CRM}$	$I_{CRM} = 3 \times I_{Cnom}$	450	A	
$V_{GES}$		-20 ... 20	V	
$t_{psc}$	$V_{CC} = 360\text{ V}$ $V_{GE} \leq 15\text{ V}$ $V_{CES} \leq 650\text{ V}$	$T_j = 150^\circ\text{C}$	6	$\mu\text{s}$
$T_j$		-40 ... 175	$^\circ\text{C}$	
<b>Inverse - Diode</b>				
$I_F$	$T_j = 175^\circ\text{C}$	$T_s = 25^\circ\text{C}$	161	A
		$T_s = 70^\circ\text{C}$	128	A
$I_{Fnom}$		150	A	
$I_{FRM}$	$I_{FRM} = 2 \times I_{Fnom}$	300	A	
$I_{FSM}$	10 ms, sin 180°, $T_j = 150^\circ\text{C}$	828	A	
$T_j$		-40 ... 175	$^\circ\text{C}$	
<b>Module</b>				
$I_{t(RMS)}$	$T_{terminal} = 80^\circ\text{C}$ , $T_{terminal} = 80^\circ\text{C}$ , 20A per spring	200	A	
$T_{stg}$		-40 ... 125	$^\circ\text{C}$	
$V_{isol}$	AC sinus 50 Hz, t = 1 min	2500	V	

### Characteristics

Symbol	Conditions	min.	typ.	max.	Unit
<b>Inverter - IGBT</b>					
$V_{CE(sat)}$	$I_C = 150\text{ A}$ $V_{GE} = 15\text{ V}$ chipelevel	$T_j = 25^\circ\text{C}$	1.45	1.77	V
		$T_j = 150^\circ\text{C}$	1.70	2.10	V
$V_{CE0}$	chipelevel	$T_j = 25^\circ\text{C}$	0.9	1	V
		$T_j = 150^\circ\text{C}$	0.82	0.9	V
$r_{CE}$	$V_{GE} = 15\text{ V}$ chipelevel	$T_j = 25^\circ\text{C}$	3.7	5.1	m $\Omega$
		$T_j = 150^\circ\text{C}$	5.9	8	m $\Omega$
$V_{GE(th)}$	$V_{GE} = V_{CE}$ , $I_C = 2.4\text{ mA}$	5.1	5.8	6.4	V
$I_{CES}$	$V_{GE} = 0\text{ V}$ $V_{CE} = 650\text{ V}$	$T_j = 25^\circ\text{C}$	0.1	0.3	mA
					mA
$C_{ies}$	$V_{CE} = 25\text{ V}$	f = 1 MHz	9.24		nF
$C_{oes}$	$V_{GE} = 0\text{ V}$	f = 1 MHz	0.60		nF
$C_{res}$		f = 1 MHz	0.27		nF
$Q_G$	- 8 V...+ 15 V		1360		nC
$R_{Gint}$	$T_j = 25^\circ\text{C}$		2		$\Omega$
$t_{d(on)}$	$V_{CC} = 300\text{ V}$ $I_C = 150\text{ A}$	$T_j = 150^\circ\text{C}$	107		ns
$t_r$	$R_{G on} = 3\ \Omega$	$T_j = 150^\circ\text{C}$	42		ns
$E_{on}$	$R_{G off} = 3\ \Omega$	$T_j = 150^\circ\text{C}$	2.2		mJ
$t_{d(off)}$	$di/dt_{on} = 4228\text{ A}/\mu\text{s}$	$T_j = 150^\circ\text{C}$	383		ns
$t_f$	$di/dt_{off} = 2857\text{ A}/\mu\text{s}$ $du/dt = 5140\text{ V}/\mu\text{s}$	$T_j = 150^\circ\text{C}$	47		ns
$E_{off}$	$V_{GE} = +15/-8\text{ V}$ $L_s = 25\text{ nH}$	$T_j = 150^\circ\text{C}$	5.1		mJ
$R_{th(j-s)}$	per IGBT, $\lambda_{paste} = 0.8\text{ W/K}^*\text{m}$		0.33		K/W

# SKiiP 24GB07E3V1

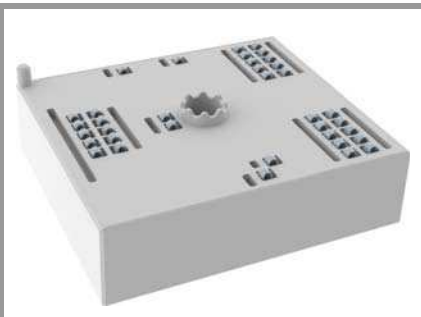

MiniSKiiP® 2 Dual

## SKiiP 24GB07E3V1

### Features

- 650V Trench IGBTs
- Robust and soft diodes in CAL technology
- Highly reliable spring contacts for electrical connections
- UL recognised: File no. E63532
- NTC T-Sensor

### Remarks

- Max. case temperature limited to  $T_C = 125^\circ\text{C}$
- Product reliability results valid for  $T_j \leq 150^\circ\text{C}$  (recommended)  
 $T_{j,op} = -40 \dots +150^\circ\text{C}$

Characteristics						
Symbol	Conditions		min.	typ.	max.	Unit
<b>Inverse - Diode</b>						
$V_F = V_{EC}$	$I_F = 150\text{ A}$ $V_{GE} = 0\text{ V}$ chipllevel	$T_j = 25^\circ\text{C}$		1.5	2	V
		$T_j = 150^\circ\text{C}$		1.6	2.1	V
$V_{F0}$	chipllevel	$T_j = 25^\circ\text{C}$		1	1.2	V
		$T_j = 150^\circ\text{C}$		0.9	1	V
$r_F$	chipllevel	$T_j = 25^\circ\text{C}$		3.3	4.9	m $\Omega$
		$T_j = 150^\circ\text{C}$		5	7.3	m $\Omega$
$I_{RRM}$	$I_F = 150\text{ A}$	$T_j = 150^\circ\text{C}$		175		A
$Q_{rr}$	$di/dt_{off} = 4058\text{ A}/\mu\text{s}$	$T_j = 150^\circ\text{C}$		14.9		$\mu\text{C}$
$E_{rr}$	$V_{GE} = -8\text{ V}$ $V_{CC} = 300\text{ V}$	$T_j = 150^\circ\text{C}$		3.7		mJ
$R_{th(j-s)}$	per Diode, $\lambda_{paste} = 0.8\text{ W}/\text{K}\cdot\text{m}$			0.45		K/W
<b>Module</b>						
$L_{CE}$				20		nH
$M_s$	to heat sink		2		2.5	Nm
$w$				50		g
<b>Temperature Sensor</b>						
$R_{100}$	$T_c = 100^\circ\text{C}$ ( $R_{25} = 5\text{ k}\Omega$ )			$493 \pm 5\%$		$\Omega$
$B_{25/85}$	$R(T) = R_{25} \cdot \exp[B_{25/85} \cdot (1/T - 1/298)]$ , [T]=K			3420		K

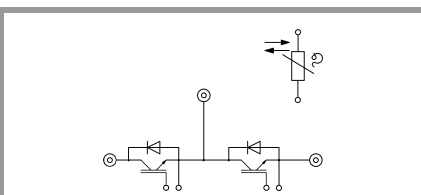

GB

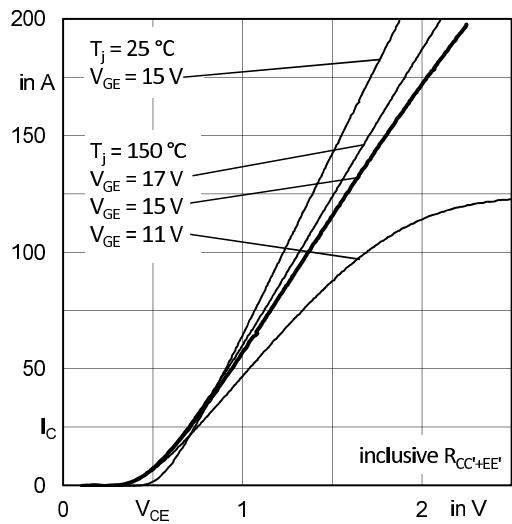

Fig. 1: Typ. output characteristic, inclusive  $R_{CC+EE}$

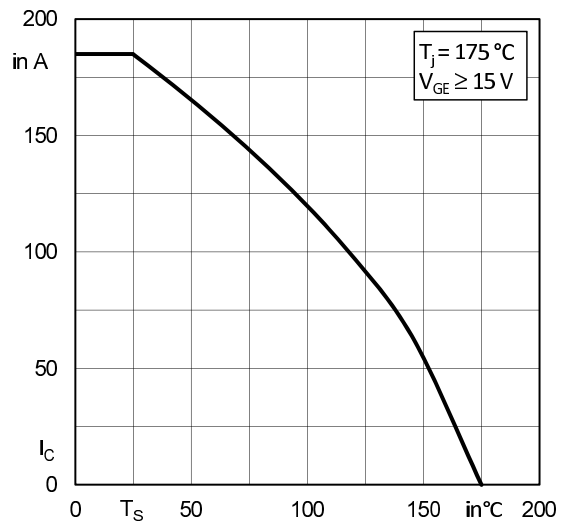

Fig. 2: Rated current vs. temperature  $I_C = f(T_S)$

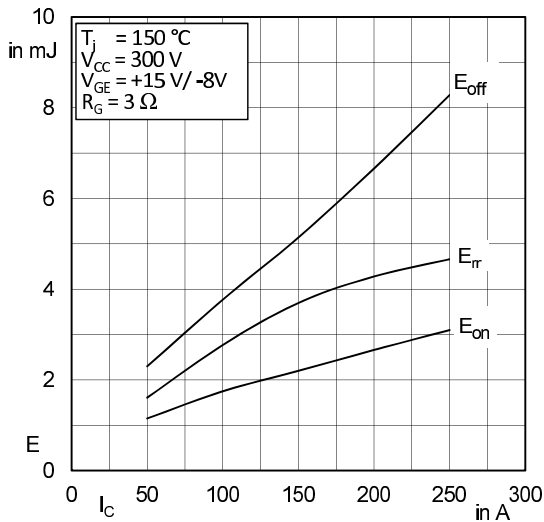

Fig. 3: Typ. turn-on /-off energy =  $f(I_C)$

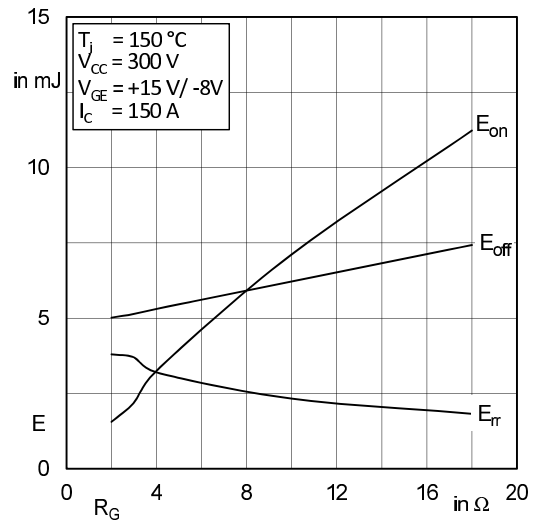

Fig. 4: Typ. turn-on /-off energy =  $f(R_G)$

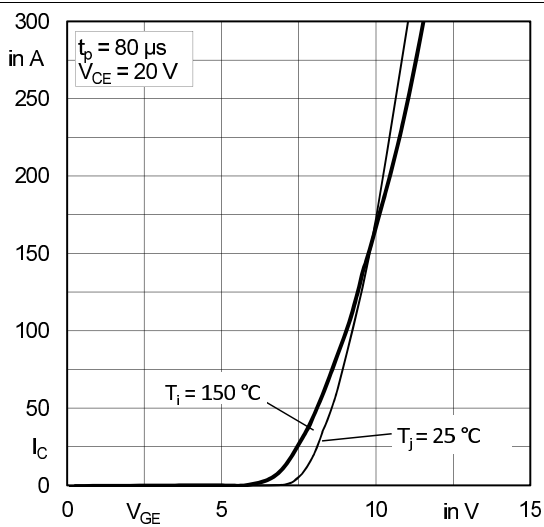

Fig. 5: Typ. transfer characteristic

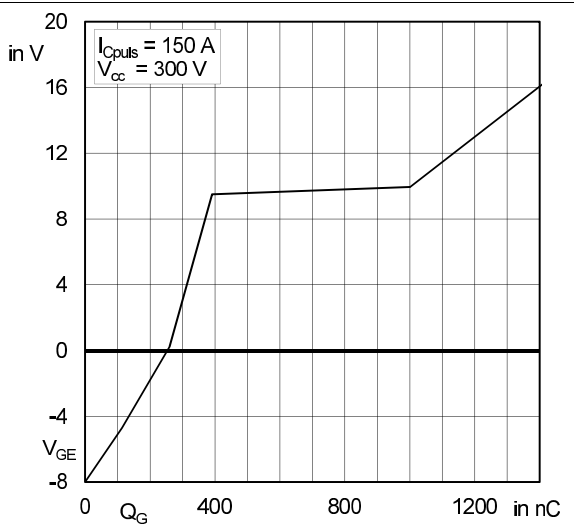

Fig. 6: Typ. gate charge characteristic

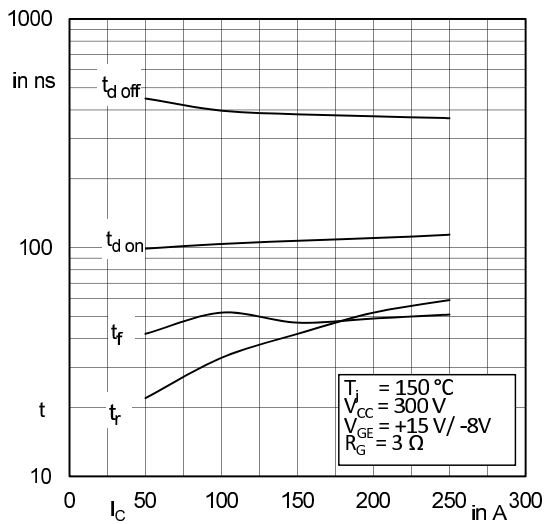

Fig. 7: Typ. switching times vs.  $I_c$

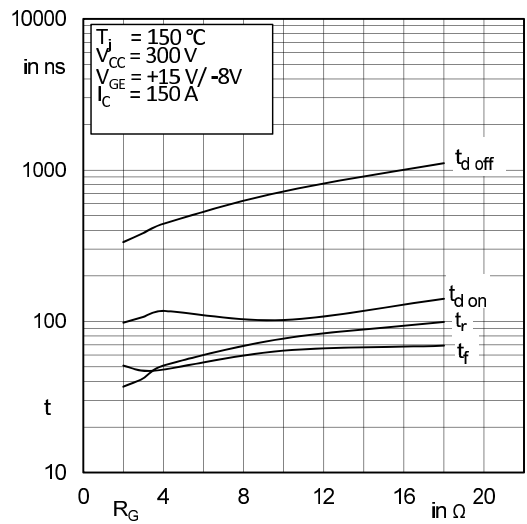

Fig. 8: Typ. switching times vs. gate resistor  $R_G$

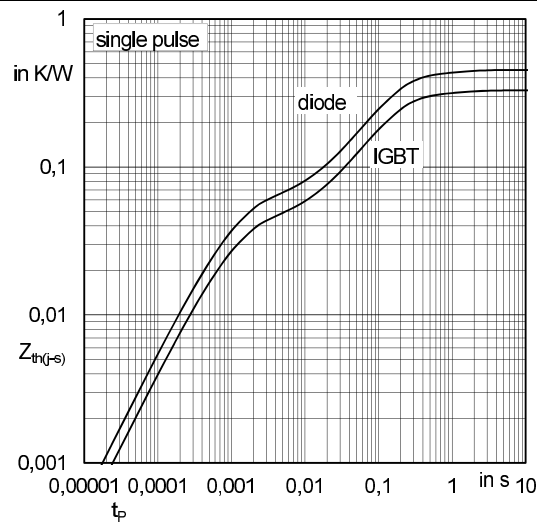

Fig. 9: Transient thermal impedance of IGBT and Diode

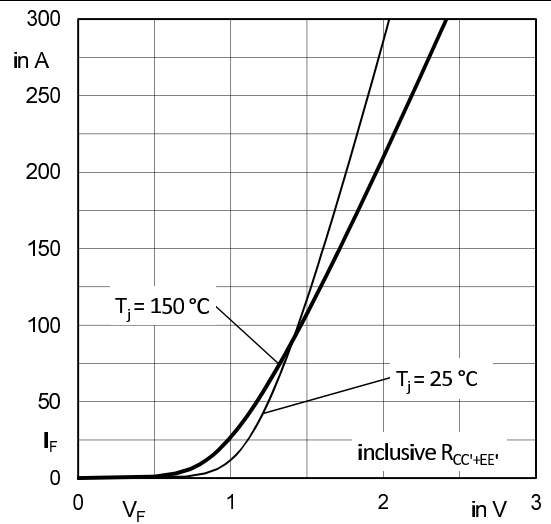

Fig. 10: CAL diode forward characteristic

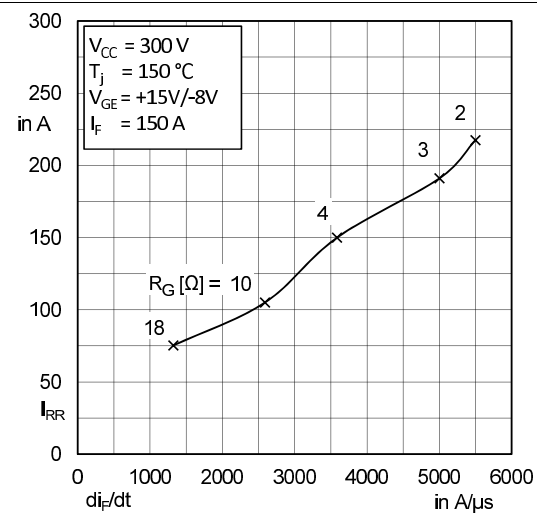

Fig. 11: Typ. CAL diode peak reverse recovery current

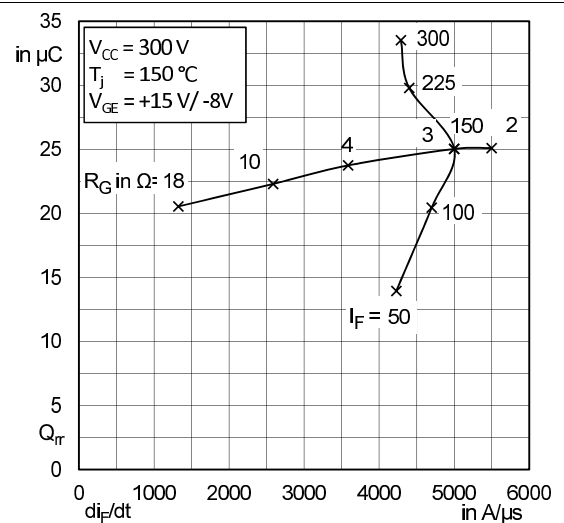
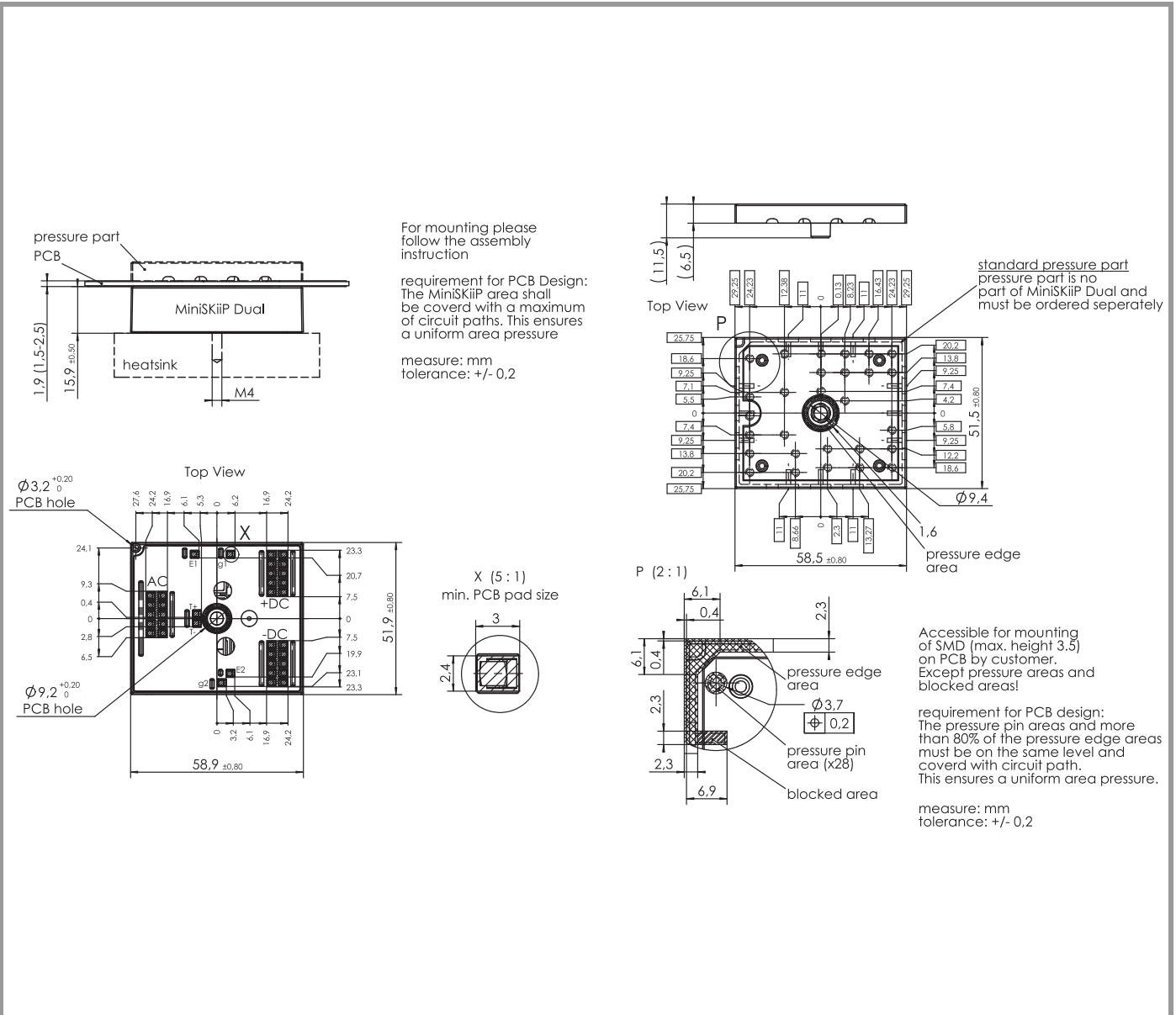
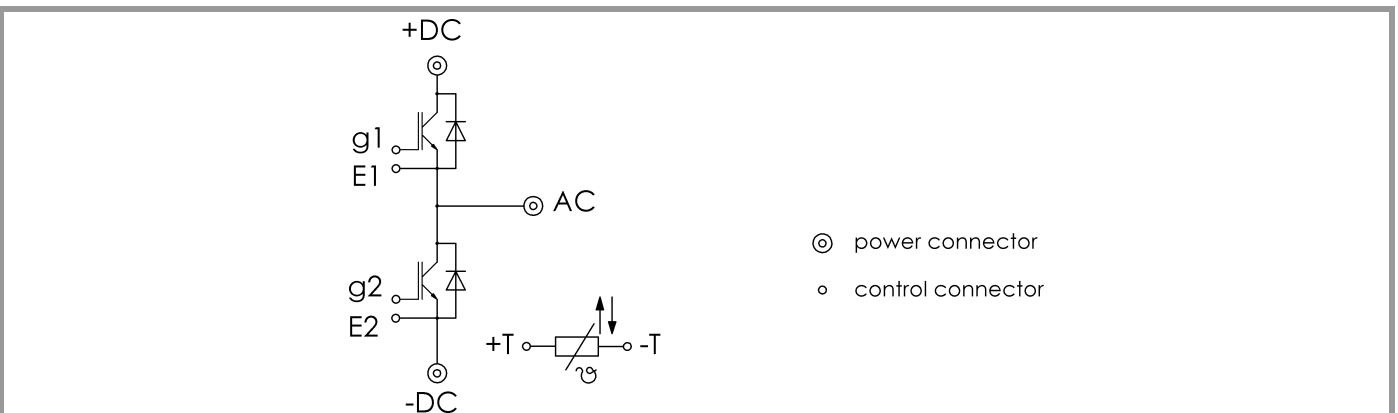

Fig. 12: Typ. CAL diode recovery charge

# SKiiP 24GB07E3V1



## pinout, dimensions



## pinout

This is an electrostatic discharge sensitive device (ESDS), international standard IEC 60747-1, Chapter IX

\* The specifications of our components may not be considered as an assurance of component characteristics. Components have to be tested for the respective application. Adjustments may be necessary. The use of SEMIKRON products in life support appliances and systems is subject to prior specification and written approval by SEMIKRON. We therefore strongly recommend prior consultation of our staff.