



SEMiSTART

Antiparallel thyristors for softstart

SKKQ 1500/18E

Features

- Compact design
- Thyristor with amplifying gate
- Pressure contact technology

Typical Applications*

- Soft starters

Remarks

- Please note: This module has no soft mold protection around the chip. It is therefore susceptible to environmental influences (dust, humidity, etc.). The humidity test according to IEC60068-2-67 is not passed by this product.
- Recommendation: The devices should be installed in control cabinets of IP54 degree of protection.

Footnotes

¹⁾ T_{jmax} up to 150°C is allowable for overload conditions, max. time period for the overload condition is 20s.

Absolute Maximum Ratings				
Symbol	Conditions	Values	Unit	
Module				
$I_{overload}$	W1C, sin. 180°, 20 s, $T_{jmax} = 150\text{ °C}$, $T_{jstart} = 40\text{ °C}$	1500	A	
I_{TSM}	10 ms	$T_j = 25\text{ °C}$	17000	A
		$T_j = 125\text{ °C}$	15000	A
i^2t	10 ms	$T_j = 25\text{ °C}$	1445000	A ² s
		$T_j = 125\text{ °C}$	1125000	A ² s
V_{RSM}		1900	V	
V_{RRM} V_{DRM}		1800	V	
T_j	¹⁾	-40 ... + 125	°C	
T_{stg}		-40 ... + 125	°C	

Characteristics					
Symbol	Conditions	min.	typ.	max.	Unit
V_T	$T_j = 25\text{ °C}$, $I_T = 1700\text{ A}$			1.5	V
$V_{T(TO)}$	$T_j = 125\text{ °C}$			0.85	V
r_T	$T_j = 125\text{ °C}$			0.3	mΩ
$I_{DD}; I_{RD}$	$T_j = 125\text{ °C}$, $V_{RD} = V_{RRM}$, per module			190	mA
t_{gd}	$T_j = 25\text{ °C}$, $I_G = 1\text{ A}$, $di_G/dt = 1\text{ A}/\mu\text{s}$		1		μs
t_{gr}	$V_D = 0.67 \cdot V_{DRM}$		2		μs
$(dv/dt)_{cr}$	$T_j = 125\text{ °C}$		1000		V/μs
$(di/dt)_{cr}$	$T_j = 125\text{ °C}$, $f = 50 \dots 60\text{ Hz}$		200		A/μs
t_q	$T_j = 125\text{ °C}$		200		μs
I_H	$T_j = 25\text{ °C}$		150	500	mA
I_L	$T_j = 25\text{ °C}$, $R_G = 33\text{ Ω}$		300	2000	mA
V_{GT}	$T_j = 25\text{ °C}$, d.c.	3			V
I_{GT}	$T_j = 25\text{ °C}$, d.c.	200			mA
V_{GD}	$T_j = 125\text{ °C}$, d.c.			0.25	V
I_{GD}	$T_j = 125\text{ °C}$, d.c.			10	mA
$R_{th(j-r)}$	continuous DC, per thyristor			0.037	K/W
M_t	to terminals	4.25		5.75	Nm
m	approx.		1200		g
Case			2		

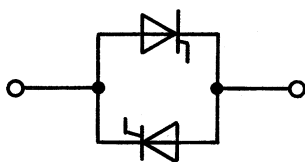

W1C

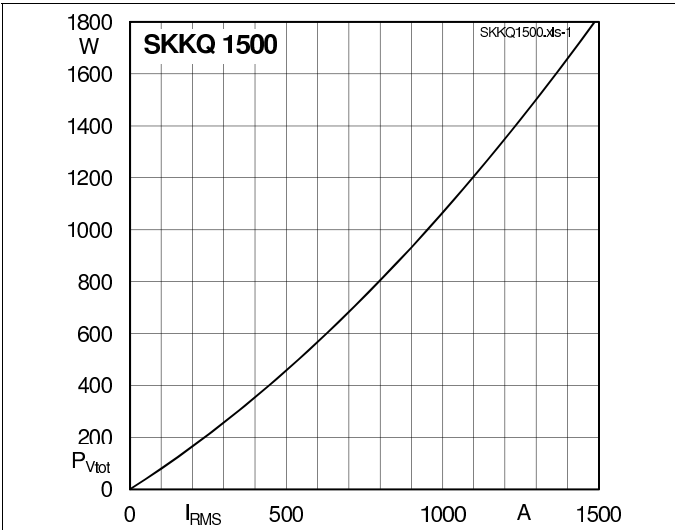

Fig. 1: Power dissipation per module vs. rms current

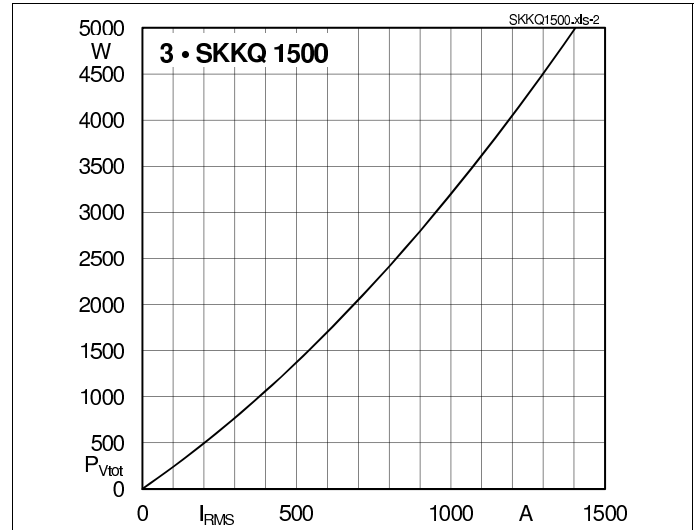

Fig. 2: Power dissipation of three modules vs. rms current

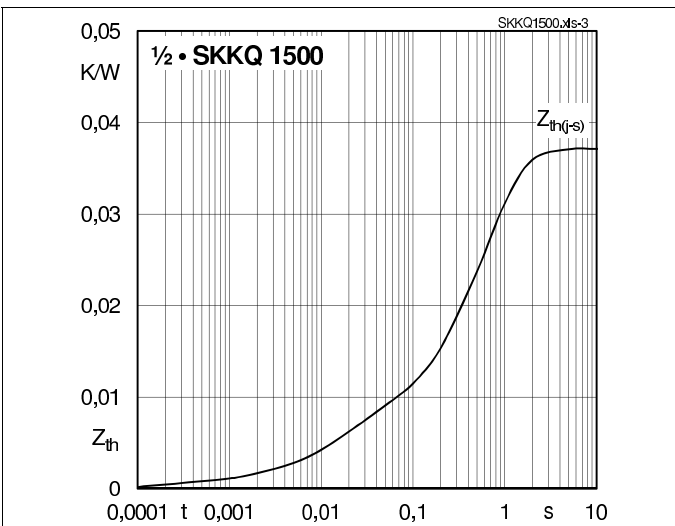

Fig. 3: Transient thermal impedance $Z_{th(j-r)}$ vs. time

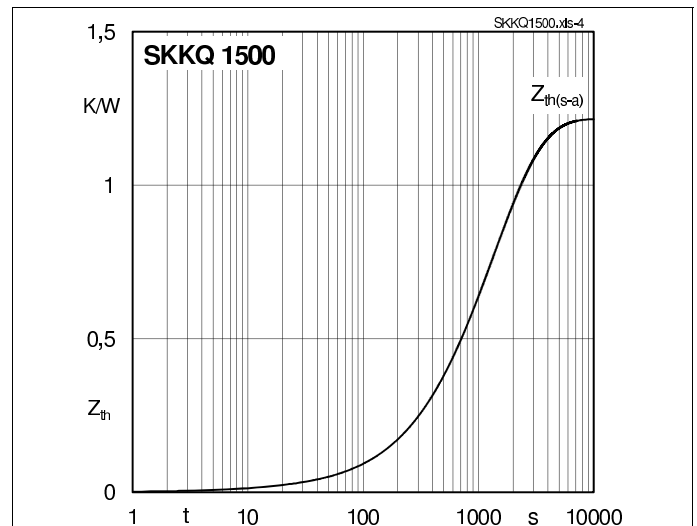

Fig. 4: Typ. transient thermal impedance $Z_{th(s-a)}$ vs. time (natural cooling)

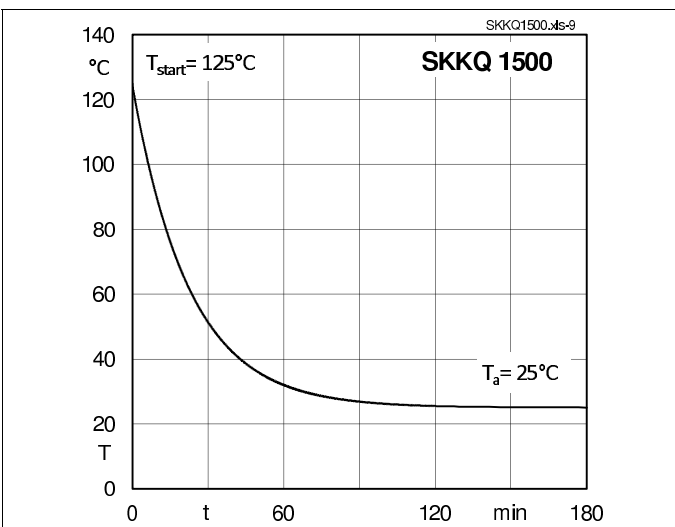

Fig. 5: Typ. cooling down vs. time (natural cooling)

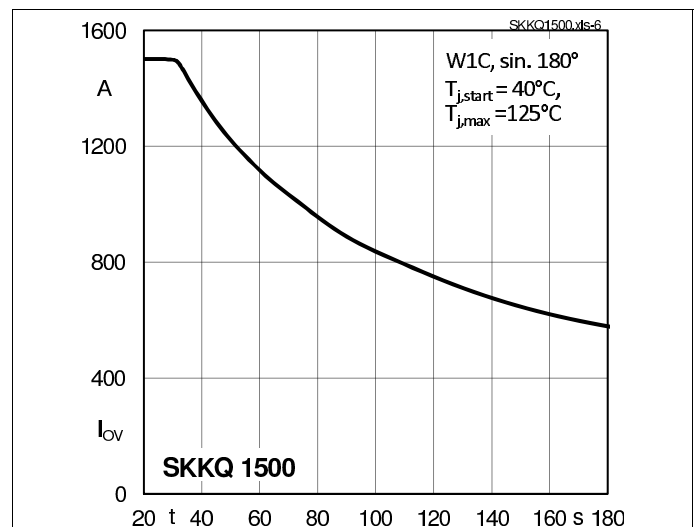

Fig. 6: Typ. overload current vs. time (natural cooling)

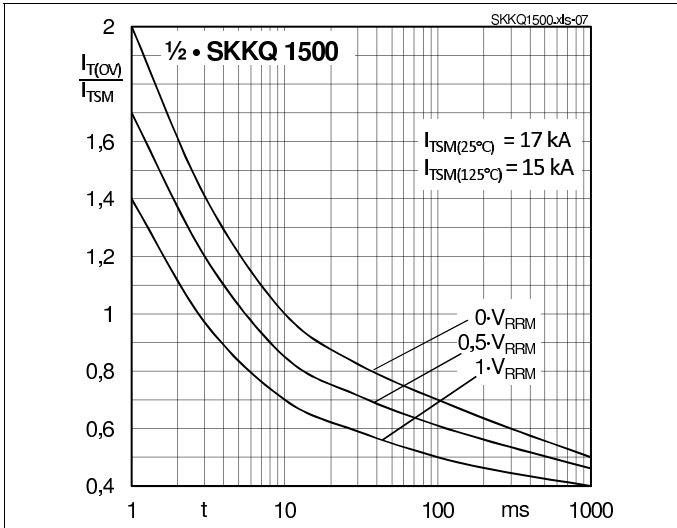

Fig. 7: Surge overload current vs. time

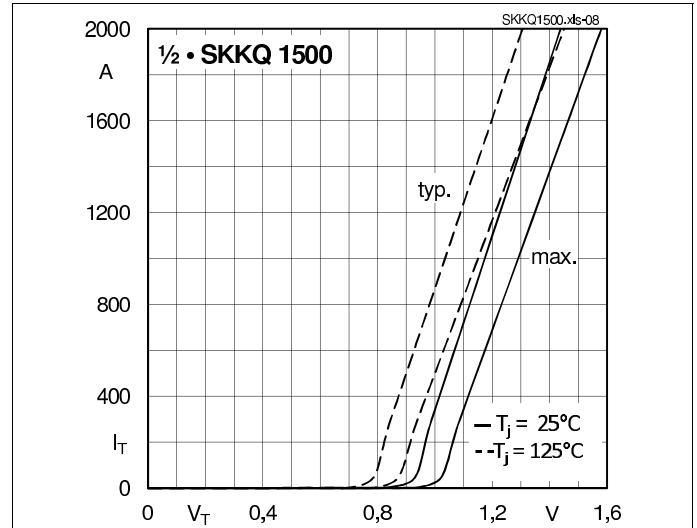

Fig. 8: On state characteristics

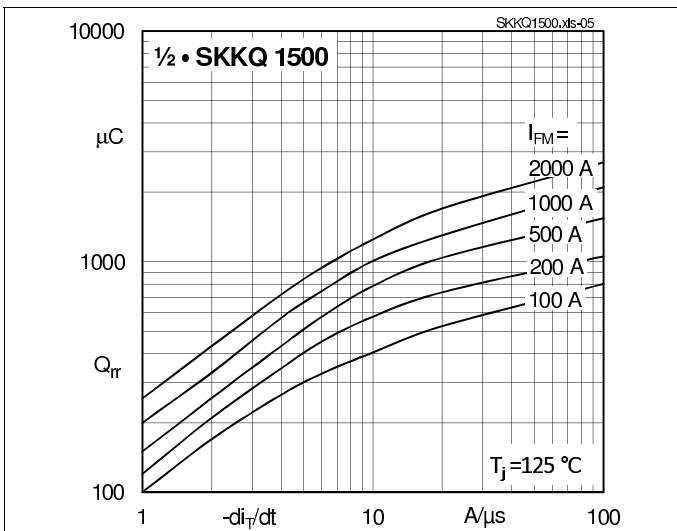

Fig. 9: Recovery charge vs. current decrease

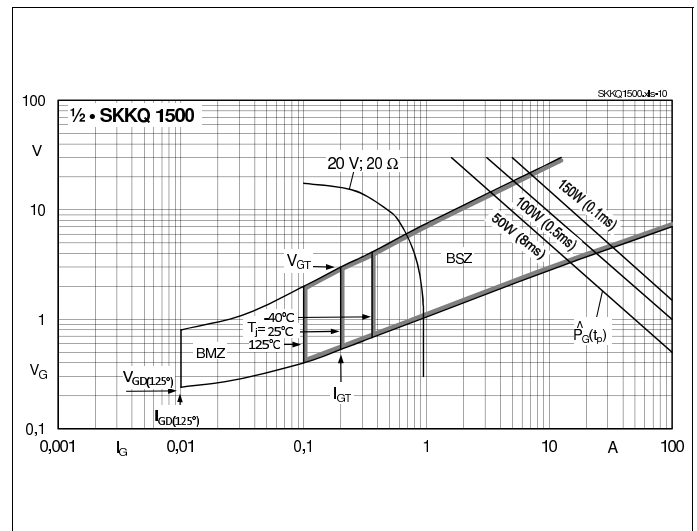
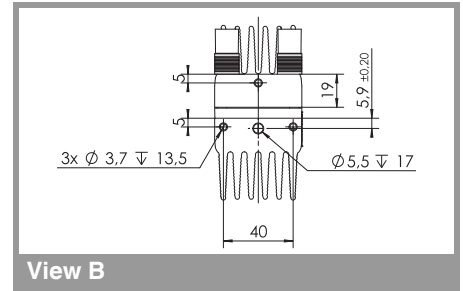
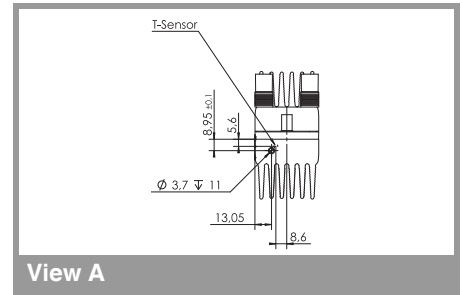
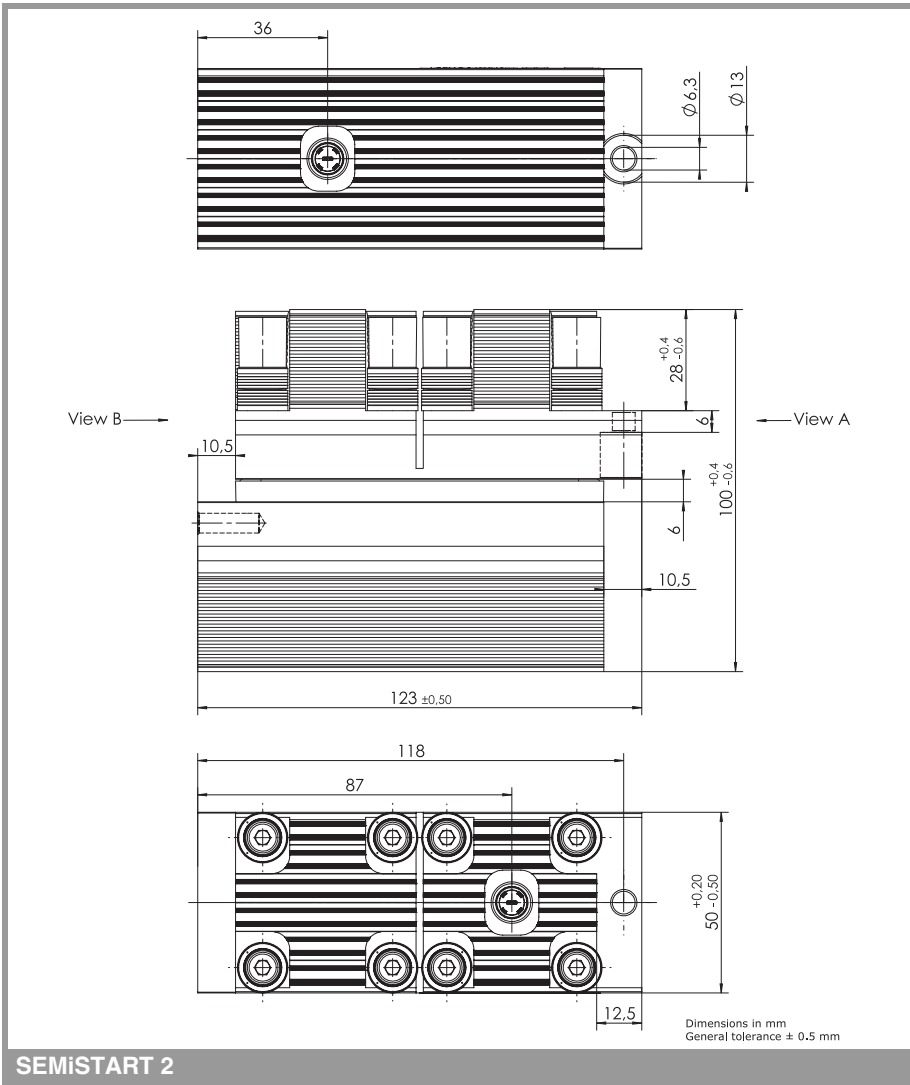

Fig. 10: Gate trigger characteristic

SKKQ 1500/18E



This is an electrostatic discharge sensitive device (ESDS), international standard IEC 60747-1, chapter IX.

*IMPORTANT INFORMATION AND WARNINGS

The specifications of SEMIKRON products may not be considered as guarantee or assurance of product characteristics ("Beschaffenheitsgarantie"). The specifications of SEMIKRON products describe only the usual characteristics of products to be expected in typical applications, which may still vary depending on the specific application. Therefore, products must be tested for the respective application in advance. Application adjustments may be necessary. The user of SEMIKRON products is responsible for the safety of their applications embedding SEMIKRON products and must take adequate safety measures to prevent the applications from causing a physical injury, fire or other problem if any of SEMIKRON products become faulty. The user is responsible to make sure that the application design is compliant with all applicable laws, regulations, norms and standards. Except as otherwise explicitly approved by SEMIKRON in a written document signed by authorized representatives of SEMIKRON, SEMIKRON products may not be used in any applications where a failure of the product or any consequences of the use thereof can reasonably be expected to result in personal injury. No representation or warranty is given and no liability is assumed with respect to the accuracy, completeness and/or use of any information herein, including without limitation, warranties of non-infringement of intellectual property rights of any third party. SEMIKRON does not assume any liability arising out of the applications or use of any product; neither does it convey any license under its patent rights, copyrights, trade secrets or other intellectual property rights, nor the rights of others. SEMIKRON makes no representation or warranty of non-infringement or alleged non-infringement of intellectual property rights of any third party which may arise from applications. Due to technical requirements our products may contain dangerous substances. For information on the types in question please contact the nearest SEMIKRON sales office. This document supersedes and replaces all information previously supplied and may be superseded by updates. SEMIKRON reserves the right to make changes.