

# SKET 330



## SEMIPACK<sup>®</sup> 4

### Thyristor Modules

#### SKET 330

#### Features

- Heat transfer through aluminium nitride ceramic isolated metal baseplate
- Precious metal pressure contacts for high reliability
- Thyristor with amplifying gate
- UL recognized, file no. E 63 532

#### Typical Applications\*

- DC motor control (e. g. for machine tools)
- Temperature control (e. g. for ovens, chemical processes)
- Professional light dimming (studios, theaters)

1) See the assembly instructions

$V_{RSM}$ V	$V_{RRM}, V_{DRM}$ V	$I_{TRMS} = 600$ A (maximum value for continuous operation) $I_{TAV} = 330$ A (sin. 180; $T_c = 78$ °C)	
900	800	SKET 330/08E	
1300	1200	SKET 330/12E	
1500	1400	SKET 330/14E	
1700	1600	SKET 330/16E	
1900	1800	SKET 330/18E	
2100	2000	SKET 330/20E	
2300	2200	SKET 330/22E	

Symbol	Conditions	Values	Units
$I_{TAV}$	sin. 180; $T_c = 85$ (100) °C;	295 (210)	A
$I_D$	P16/300F; $T_a = 35$ °C; B2 / B6	530 / 665	A
$I_{RMS}$	P16/400F; $T_a = 35$ °C; W1 / W3	685 / 3 * 550	A
$I_{TSM}$	$T_{vj} = 25$ °C; 10 ms	9000	A
	$T_{vj} = 130$ °C; 10 ms	8000	A
$i^2t$	$T_{vj} = 25$ °C; 8,3 ... 10 ms	405000	A <sup>2</sup> s
	$T_{vj} = 130$ °C; 8,3 ... 10 ms	320000	A <sup>2</sup> s
$V_T$	$T_{vj} = 25$ °C; $I_T = 1500$ A	max. 2,05	V
$V_{T(TO)}$	$T_{vj} = 130$ °C	max. 1,2	V
$r_T$	$T_{vj} = 130$ °C	max. 0,55	mΩ
$I_{DD}, I_{RD}$	$T_{vj} = 130$ °C; $V_{RD} = V_{RRM}; V_{DD} = V_{DRM}$	max. 200	mA
$t_{gd}$	$T_{vj} = 25$ °C; $I_G = 1$ A; $di_G/dt = 1$ A/μs	1	μs
$t_{gr}$	$V_D = 0,67 * V_{DRM}$	2	μs
$(di/dt)_{cr}$	$T_{vj} = 130$ °C	max. 125	A/μs
$(dv/dt)_{cr}$	$T_{vj} = 130$ °C	max. 1000	V/μs
$t_q$	$T_{vj} = 130$ °C,	150 ... 200	μs
$I_H$	$T_{vj} = 25$ °C; typ. / max.	150 / 500	mA
$I_L$	$T_{vj} = 25$ °C; $R_G = 33$ Ω; typ. / max.	500 / 2000	mA
$V_{GT}$	$T_{vj} = 25$ °C; d.c.	min. 3	V
$I_{GT}$	$T_{vj} = 25$ °C; d.c.	min. 200	mA
$V_{GD}$	$T_{vj} = 130$ °C; d.c.	max. 0,25	V
$I_{GD}$	$T_{vj} = 130$ °C; d.c.	max. 10	mA
$R_{th(j-c)}$	cont.	0,09	K/W
	sin. 180	0,095	K/W
	rec. 120	0,11	K/W
$R_{th(c-s)}$		0,02	K/W
$T_{vj}$		- 40 ... + 130	°C
$T_{stg}$		- 40 ... + 130	°C
$V_{isol}$	a. c. 50 Hz; r.m.s.; 1s / 1 min.	3600 / 3000	V~
$M_s$	to heatsink	$5 \pm 15$ % <sup>1)</sup>	Nm
$M_t$	to terminal	$17 \pm 15$ %	Nm
$a$		$5 * 9,81$	m/s <sup>2</sup>
$m$	approx.	940	g
Case		A 36	

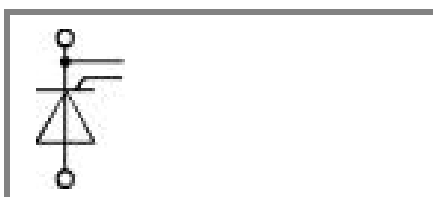

SKET

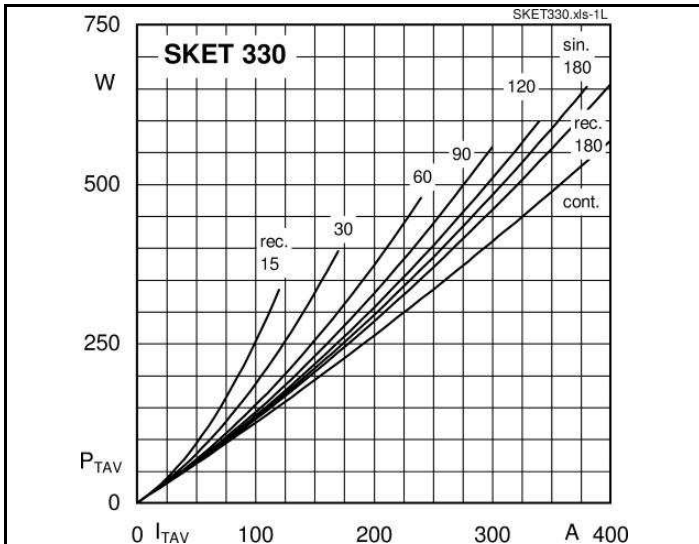

Fig. 1L Power dissipation per thyristor vs. on-state current

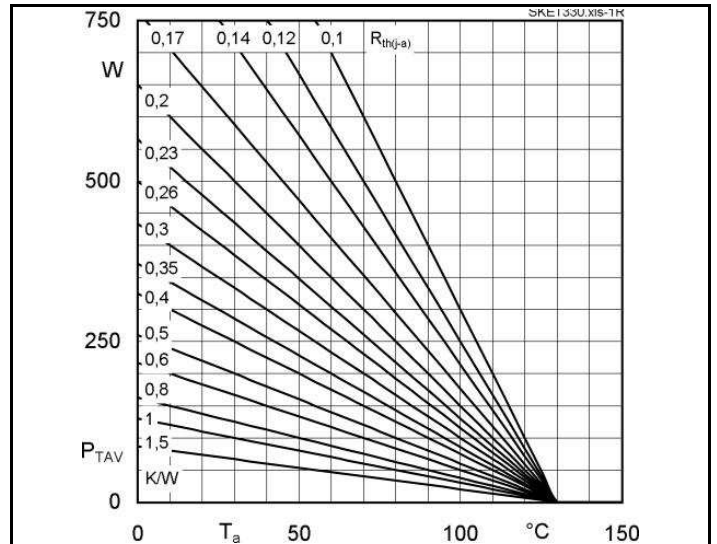

Fig. 1R Power dissipation per thyristor vs. ambient temp.

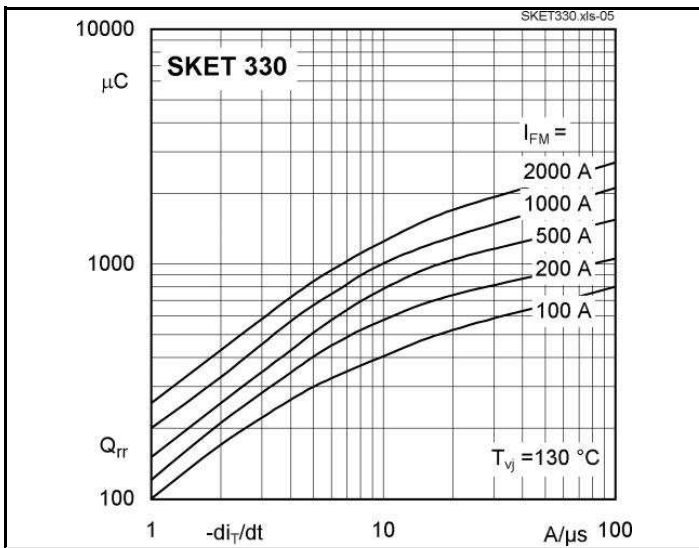

Fig. 5 Recovered charge vs. current decrease

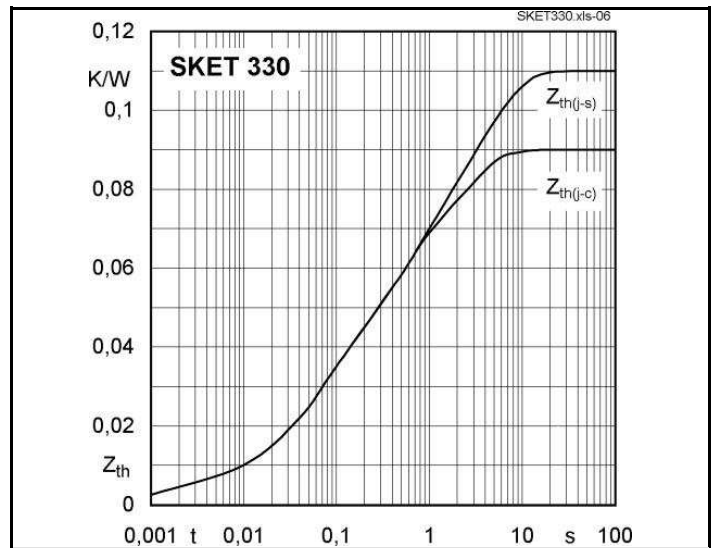

Fig. 6 Transient thermal impedance vs. time.

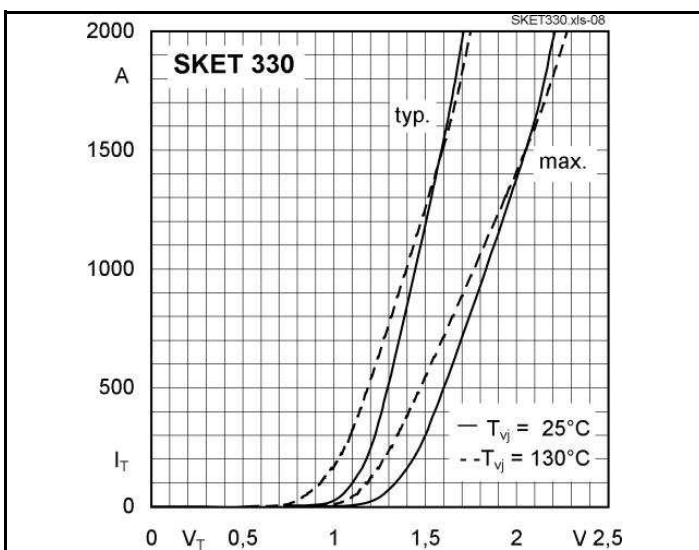

Fig. 7 On-state characteristics

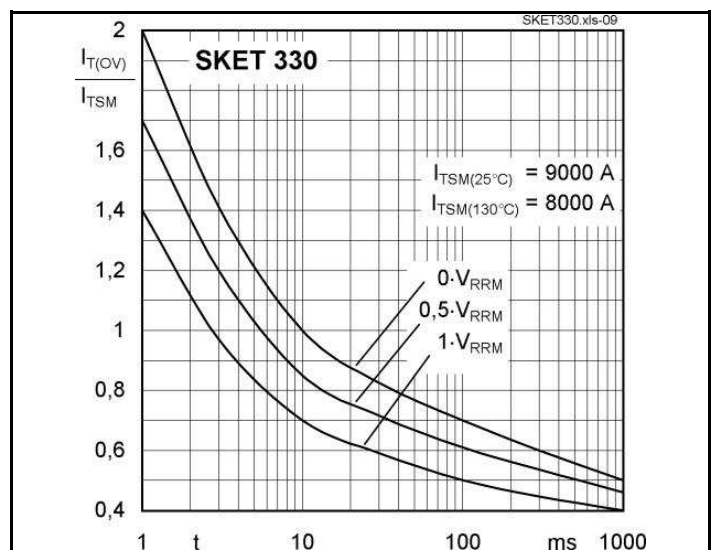
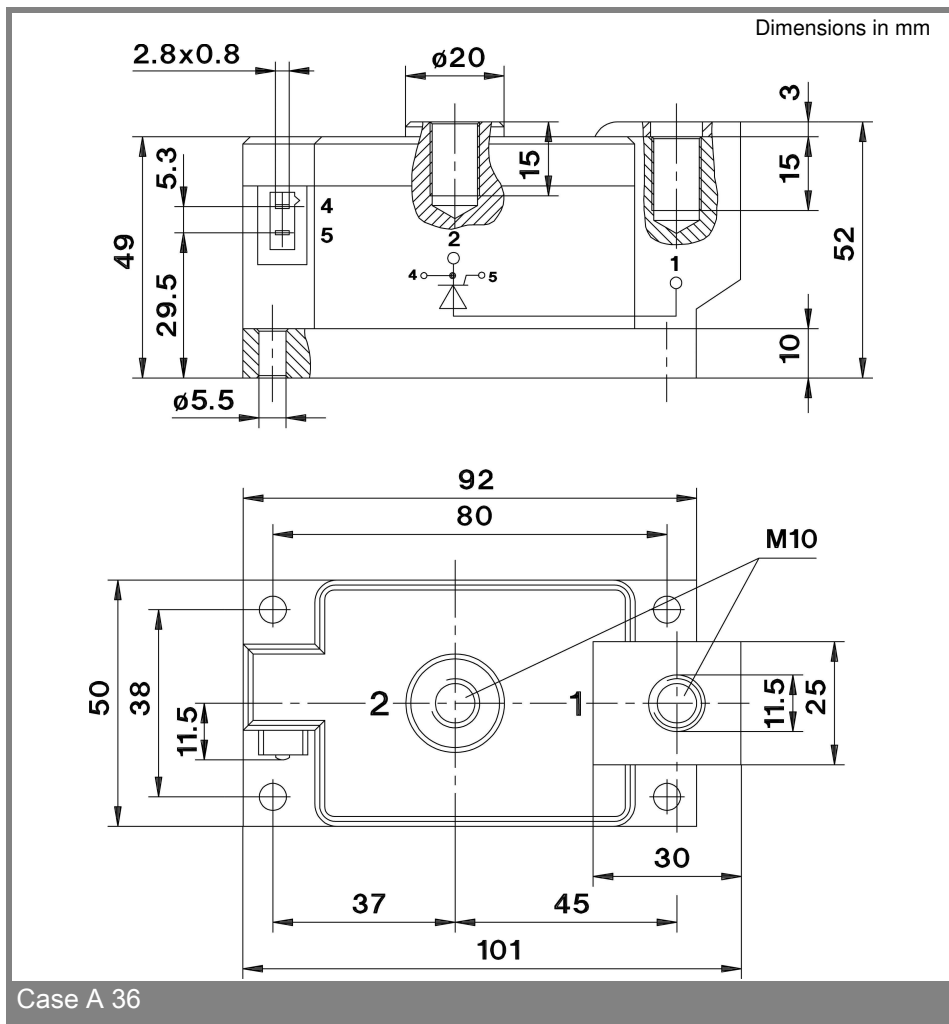
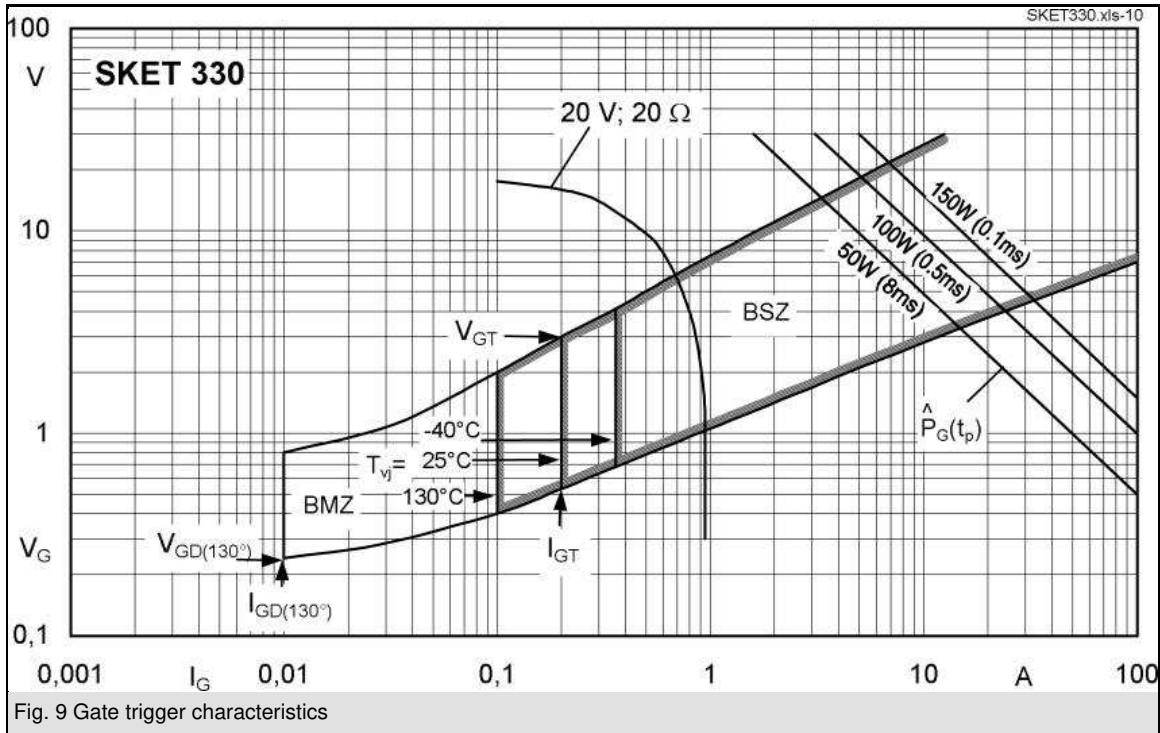

Fig. 8 Surge overload current vs. time



\* The specifications of our components may not be considered as an assurance of component characteristics. Components have to be tested for the respective application. Adjustments may be necessary. The use of SEMIKRON

# RECTIFIER DIODE THYRISTOR MODULE

products in life support appliances and systems is subject to prior specification and written approval by SEMIKRON. We therefore strongly recommend prior consultation of our staff.